

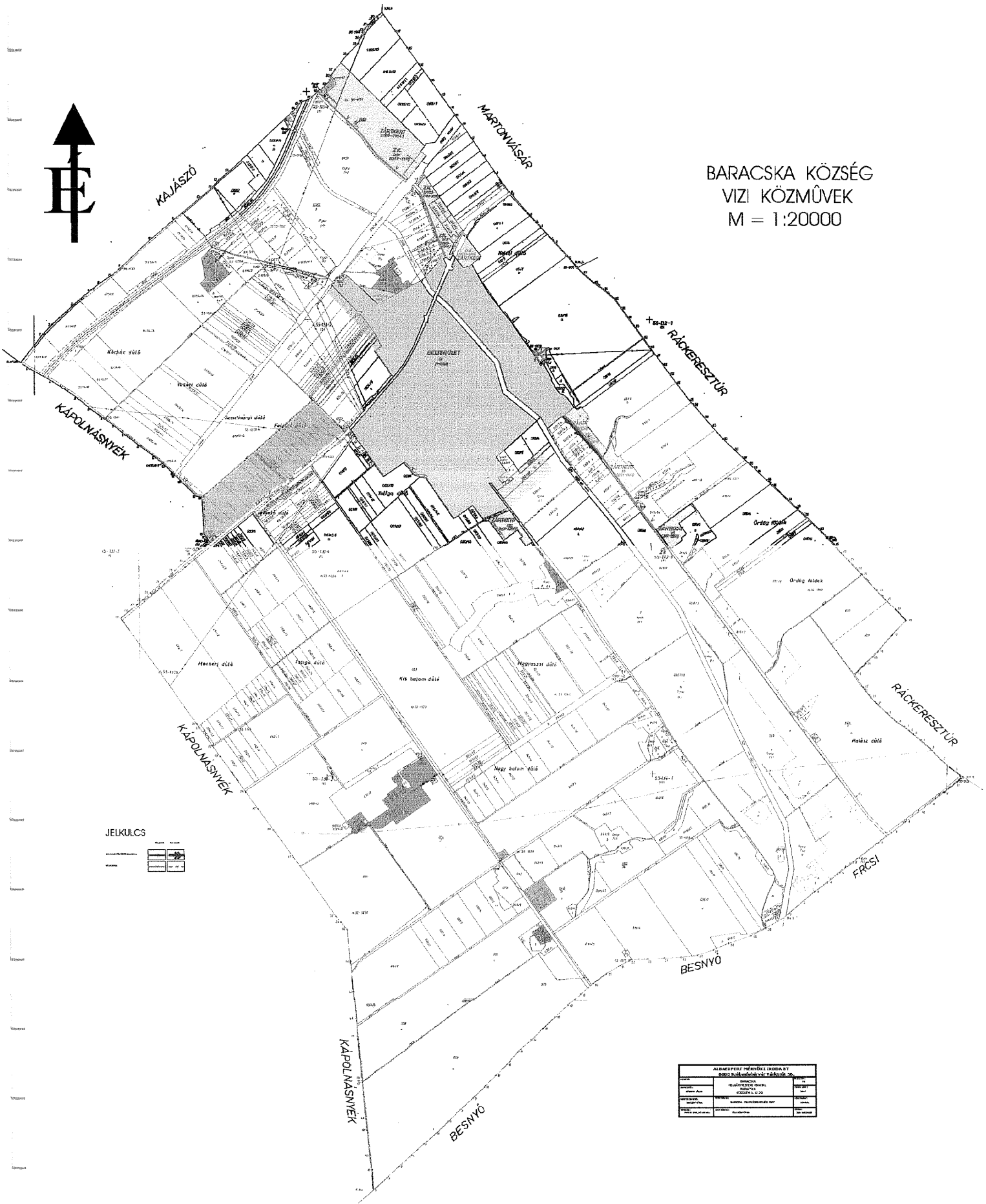

BARACSKA KÖZSÉG
VIZI KÖZMŰVEK
M = 1:20000



JELKULCS

	Vízvezeték
	Vízgyűjtő
	Vízgyűjtő
	Út
	Parcellahatár

BARACSKA KÖZSÉG VIZI KÖZMŰVEK			
ÉSZAK	BARACSKA	NYUGAT	KELET
1:20000	1:20000	1:20000	1:20000
1:20000	1:20000	1:20000	1:20000
1:20000	1:20000	1:20000	1:20000
1:20000	1:20000	1:20000	1:20000



BARACSKA KÖZSÉG
ENERGIA KÖZMŰVEK
M = 1:20000

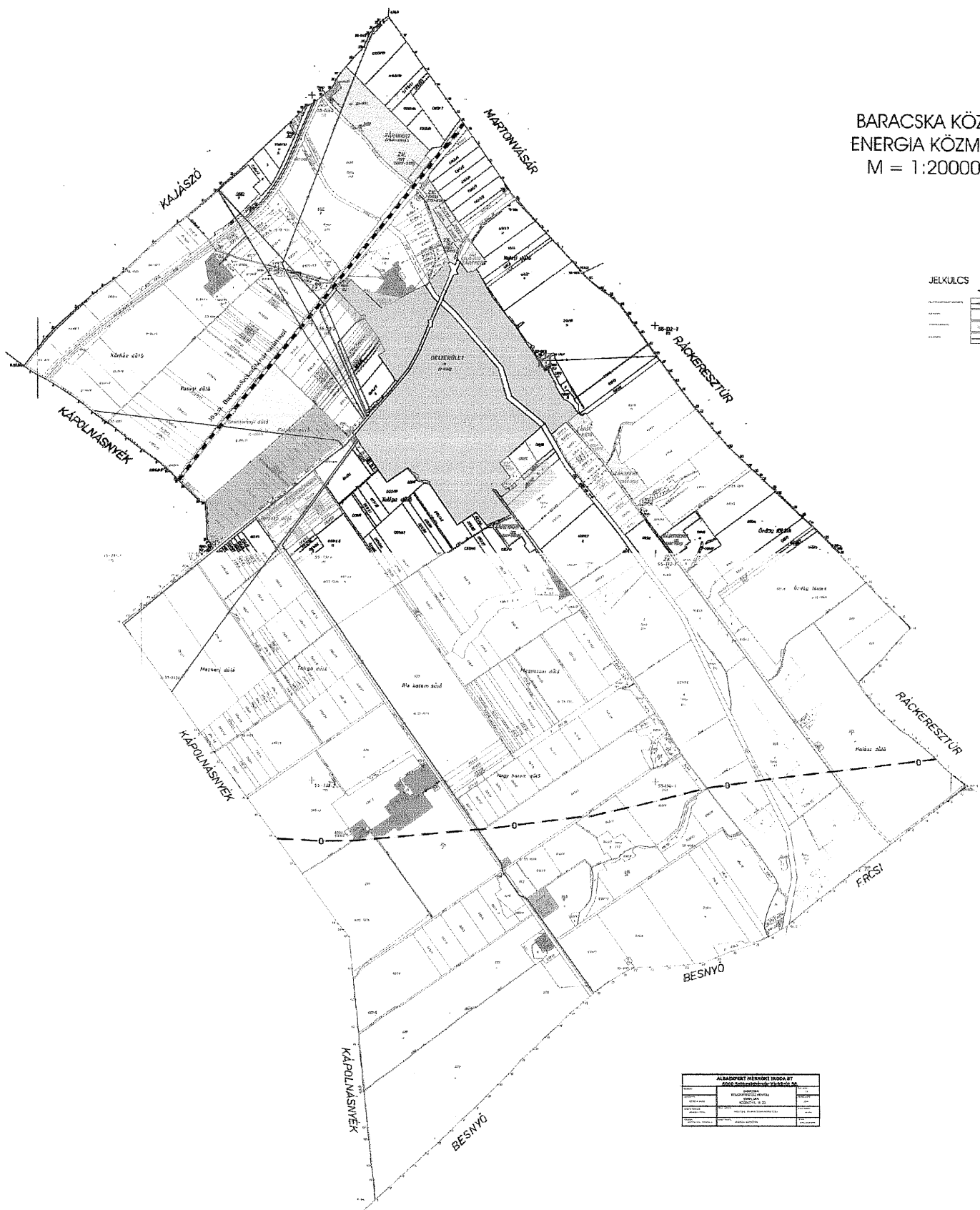

JELKULCS

.....
.....
.....

Állománytervezési terv és Álló szerkezetek terve	
.....
.....
.....
.....
.....

JELMAGYARÁZAT

Szelvény helyek:

3. Közművek:

Csapadékvíz

Távközlés

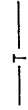
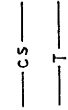

BARACSKA

KÖZMŰHELYSÍNRAJZ

M=1:4000



BARACSKA

KÖZMŰHELYSZÍNRAJZ MI=1:4000

JELMAGYARÁZAT

Szelvény helyek: 

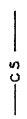
3. Közművek:
Csapadékvíz 

Távközlés 

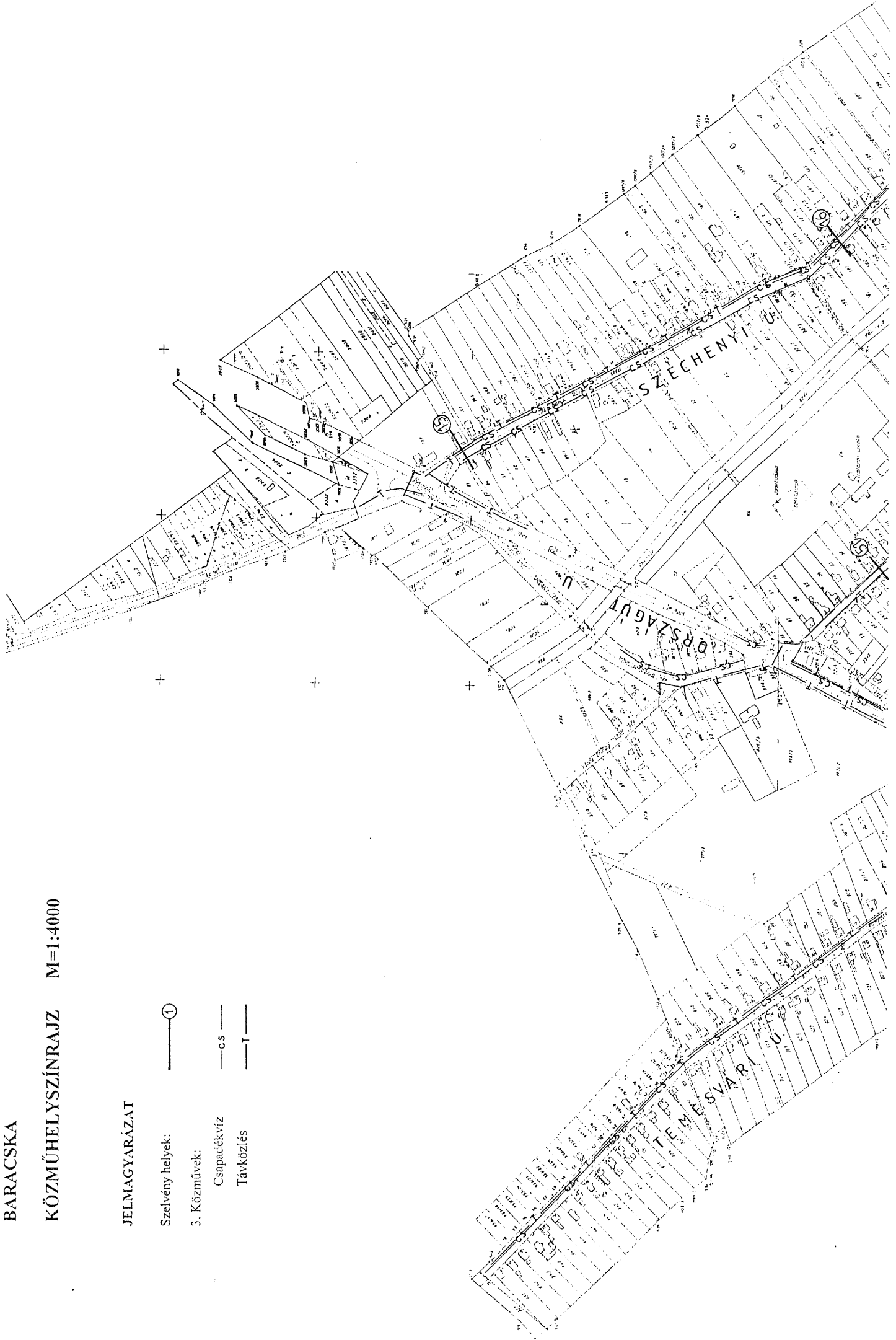



BARACSKA
 KÖZMŰHELYSZÍNRAJZ M=1:4000

JELMAGYARÁZAT

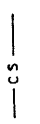
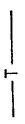
- Szelvény helyek: 
3. Közművek:
- Csapadékvíz 
 - Távközlés 

JELMAGYARÁZAT

Szelvény helyek:

• 3. Közművek

Ivóvíz

Szennyvíz

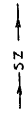
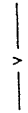

BARACSKA

KÖZMŰHELYSZÍNRAJZ M=1:4000



BARACSKA

KÖZMŰHELYSZÍNRAJZ M=1:4000

JELMAGYARÁZAT

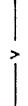
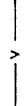
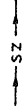
- Szelvény helyek: 
- 3. Közművek: 
- Ivóvíz: 
- Szennyvíz: 

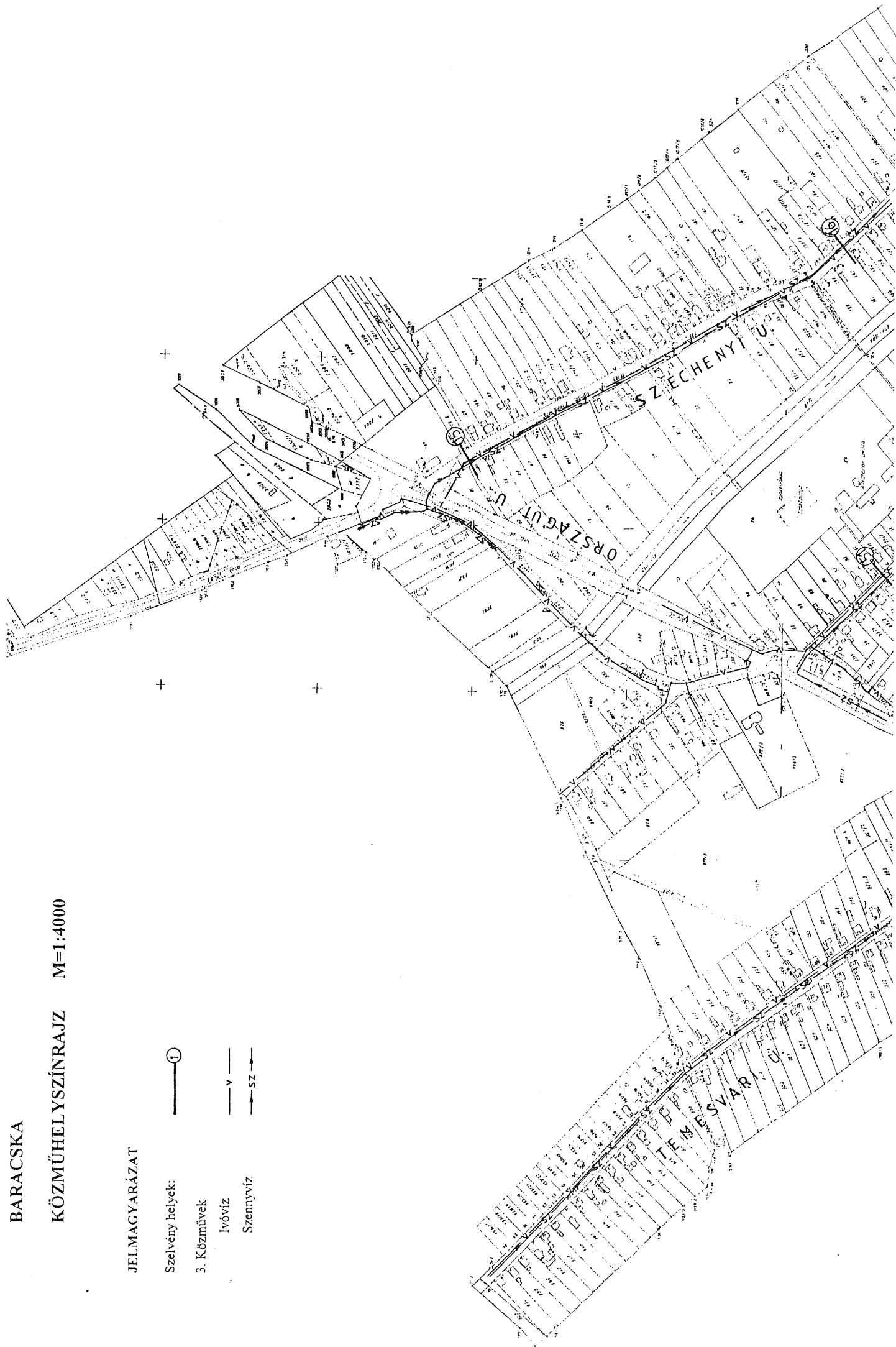

BARACSKA

KÖZMŰHELYSZÍNRAJZ M=1:4000



JELMAGYARÁZAT

- Szelvény helyek: ○
- 3. Közművek: — V —
- Ivóvíz: — SZ —
- Szennyvíz: — SZ —

~ 330 m szennyvíz-tisztító ○

JELMAGYARÁZAT

Szelvény helyek:

3. Közművek:

Gázvezeték

Elektromos hálózat



BARACSKA

KÖZMŰHELYSÍNRAJZ M=1:4000

BARACSKA

KÖZMŰHELYSZÍNRAJZ M=1:4000

JELMAGYARÁZAT



Szelvény helyek:

3. Közművek:

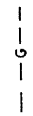

Gáz vezetékek



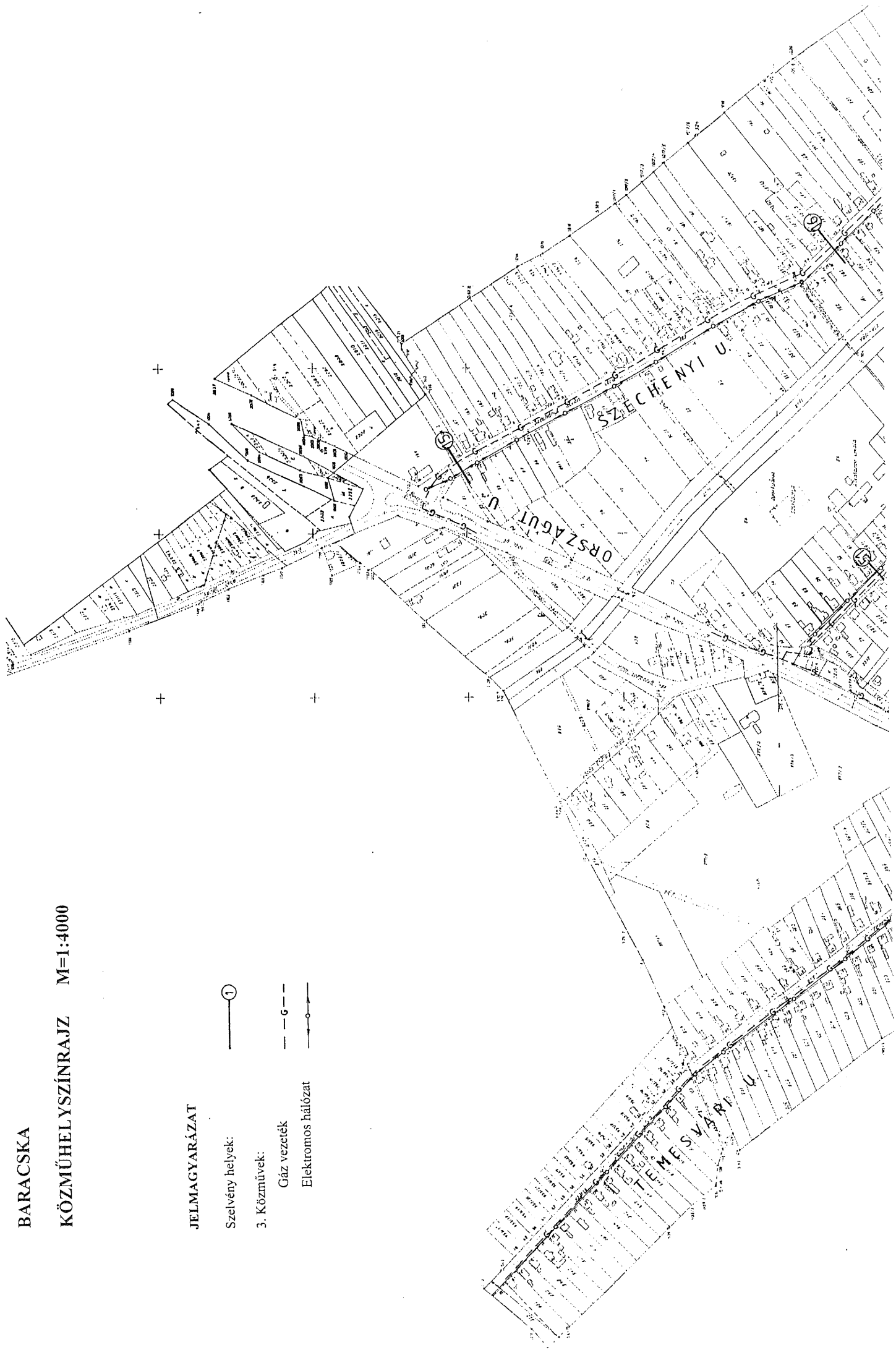

Elektromos hálózat



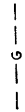
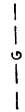

JELMAGYARÁZAT

- Szelvény helyek: 
- 3. Közművek: 
- Gázvezetékek 
- Elektromos hálózat 

BARACSKA

KÖZMŰHELYSZÍNRAJZ M=1:4000

M I N T A S Z E L V É N Y M = 1 : 100

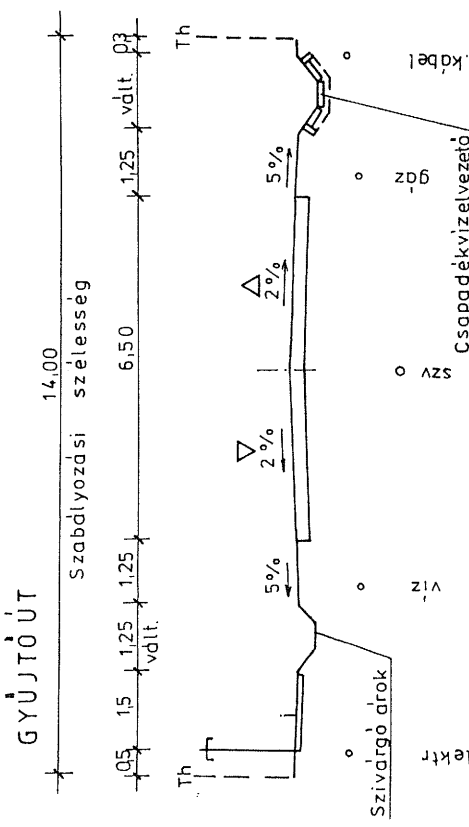
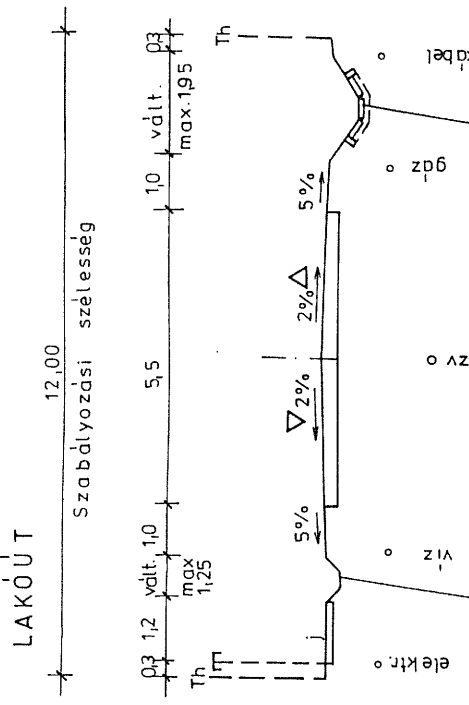
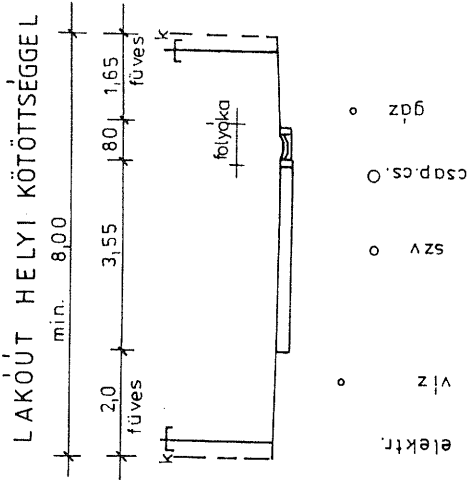

J Á R M Ű T A L Á L K O Z Á S O K

v = 30 - 50 km / ó

Tehergépkocsi / Tehergépkocsi

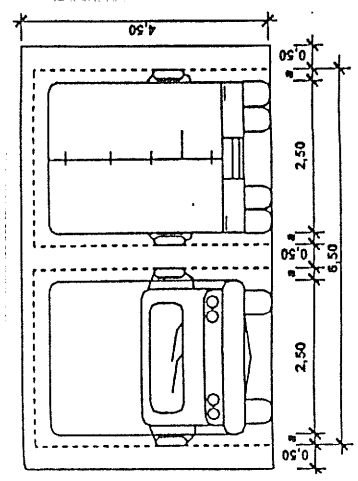

Tehergépkocsi / Tehergépkocsi

J Á R M Ű T A L Á L K O Z Á S O K

v = < 30 km / ó

Tehergépkocsi / Tehergépkocsi

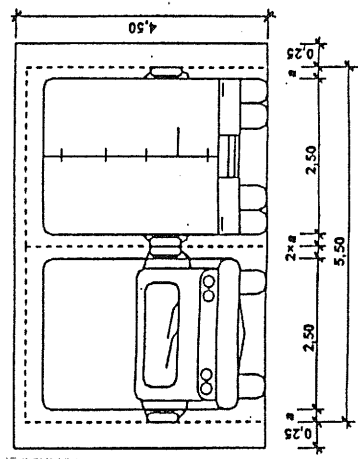

Tehergépkocsi / Tehergépkocsi

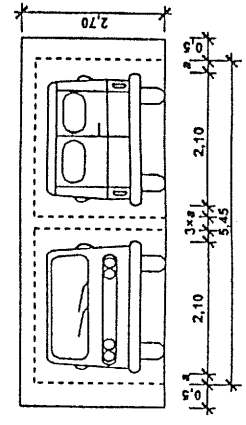

Kistehergépkocsi / Kistehergépkocsi

J Á R M Ű T A L Á L K O Z Á S O K

v < 30 km / ó

Tehergépkocsi / Kerékpár

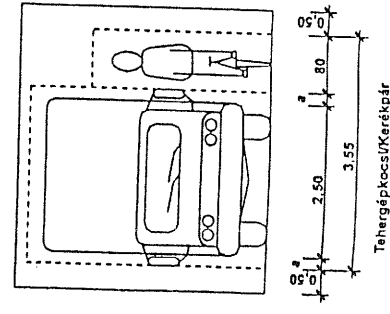

Tehergépkocsi / Kerékpár

LAKÓ UTAK

TEMESVÁRI TOMPA U. FEHÉRVÁRI U. HUNYADI U. PETŐFI U.
JÓZSEF U.

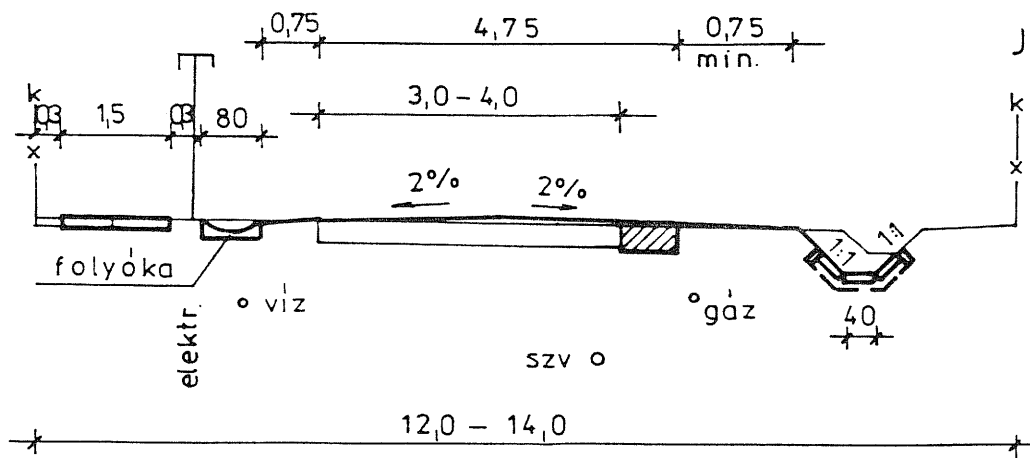

ARANY J U. ADY E U. RÁKÓCZI KÖZ ZRINYI U.

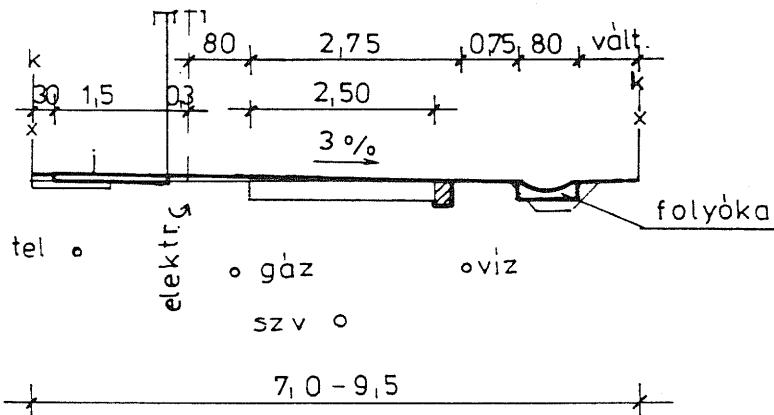

ADY E U. KASSAI U. POZSONYI U. MOLNÁR U.

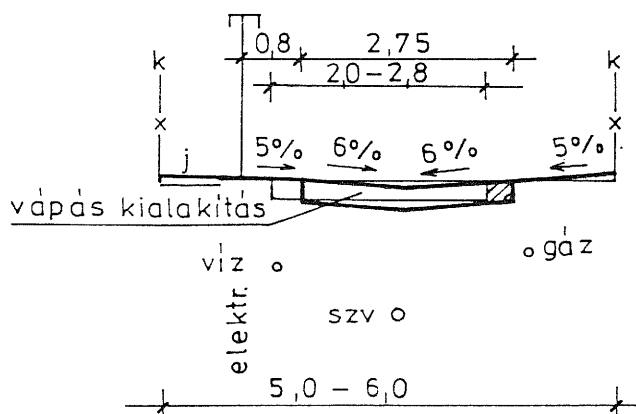

GYÜJTŐ UTAK CSATLAKOZÁSA
A 7-ES ÚTHOZ

UT.2-218

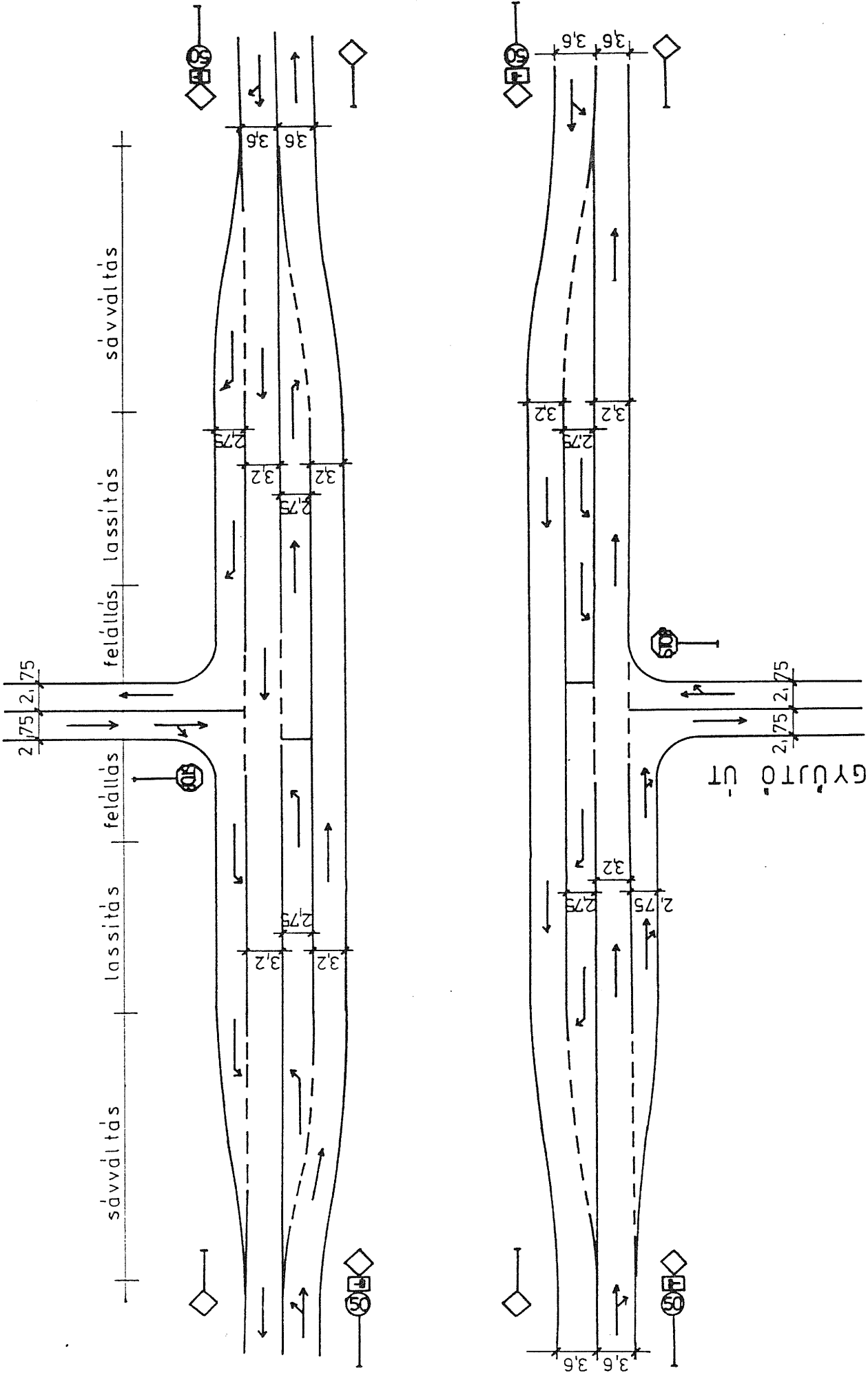

KÖZÚT ORSZÁG ÚT

21-21,5

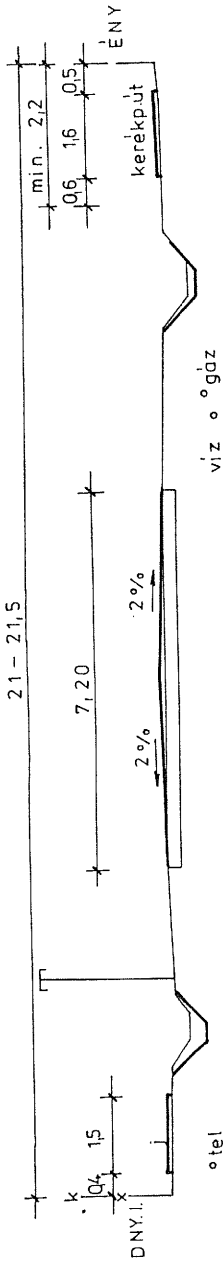

GYŰJTŐ UTAK KOSSUTH U. o szv

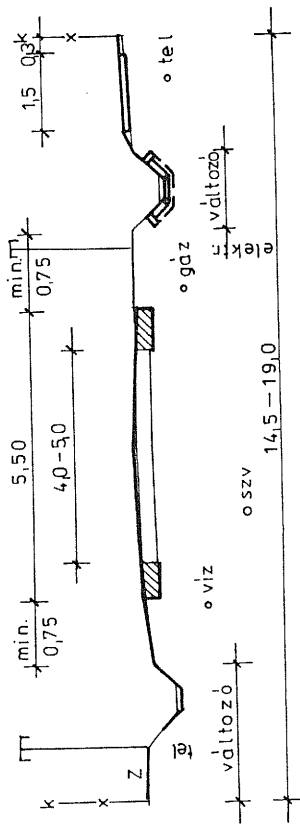

14,5-19,0

SZÉCHENYI UTCA

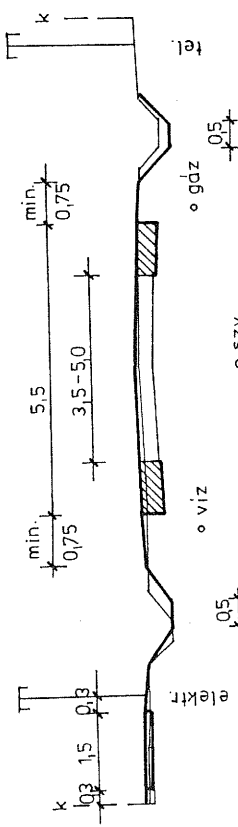

KOLOZSVÁRI ÚT

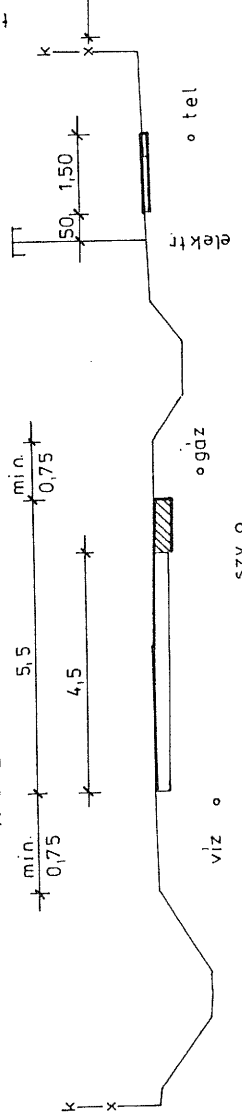

20,0

RÁKÓCZI U.

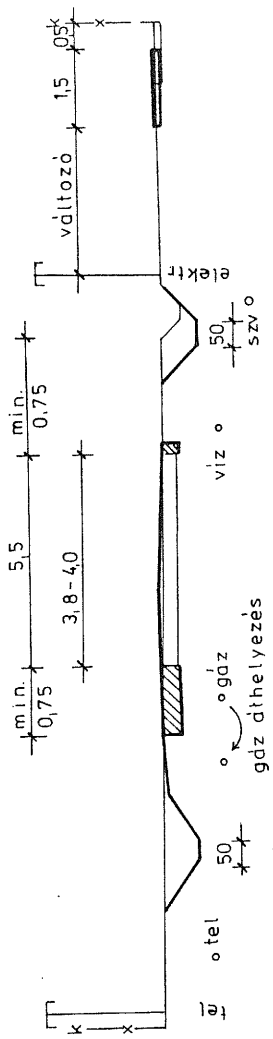

18,0-19,0

ARADI U.

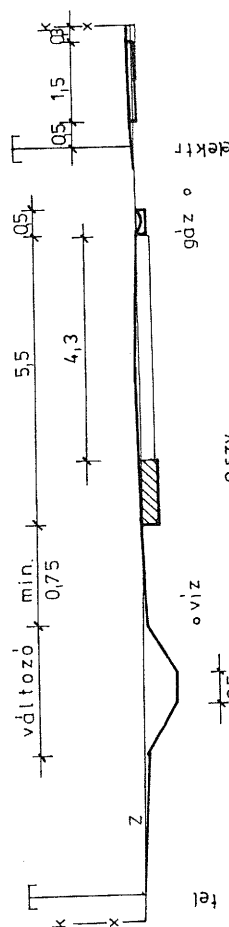

160-170

ORSZÁGÚT U. (1.)

RÁKÓCZI F. U. (3.)

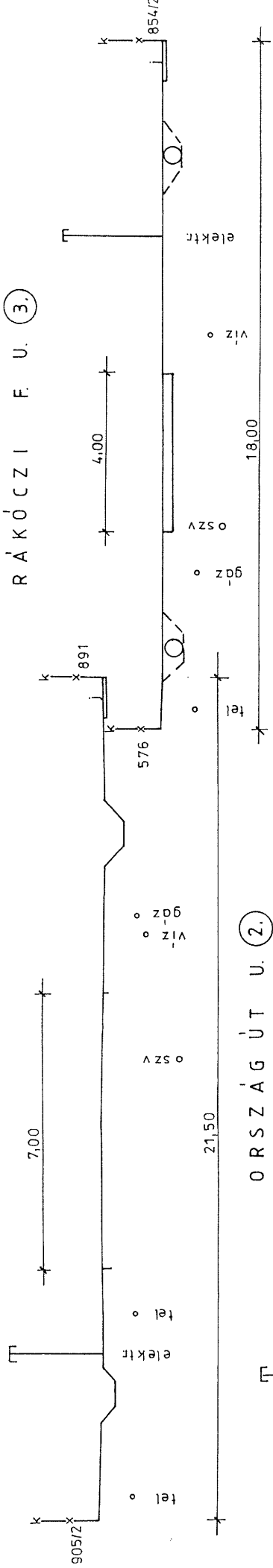

ORSZÁGÚT U. (2.)

RÁKÓCZI F. U. (4.)

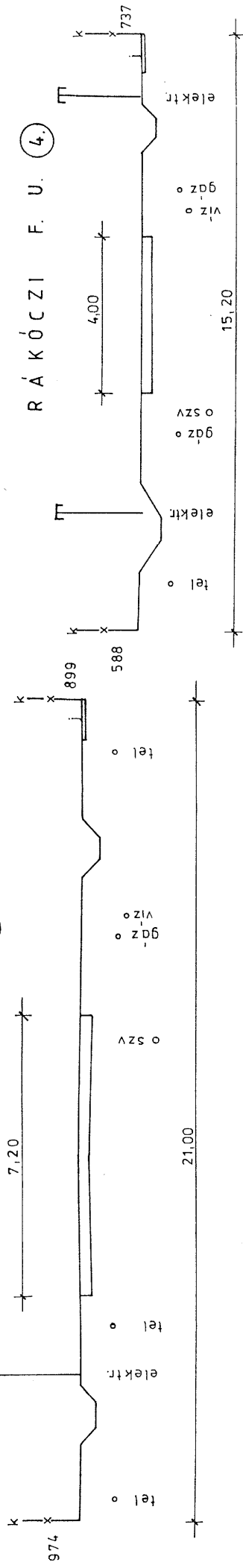

RÁKÓCZI F. U. (5)

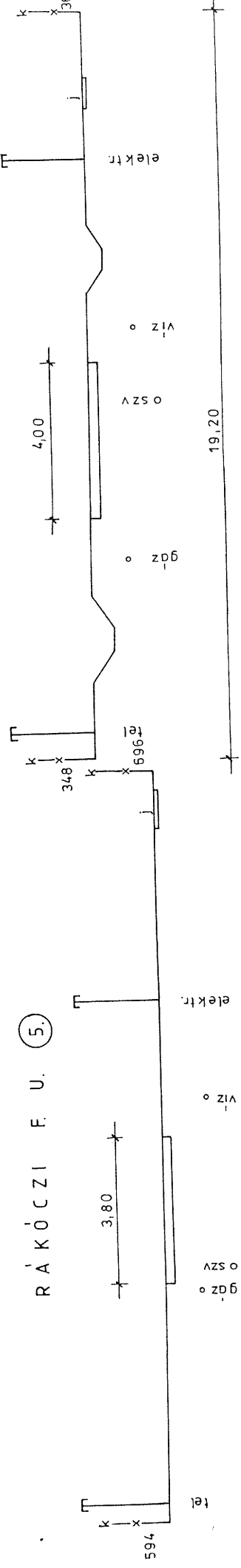

RÁKÓCZI F. U. (6)

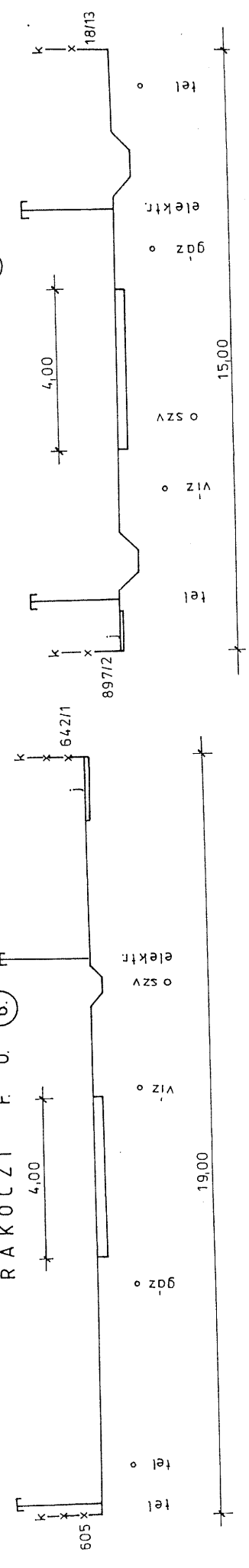

SZÉCHENYI I. U. (15)

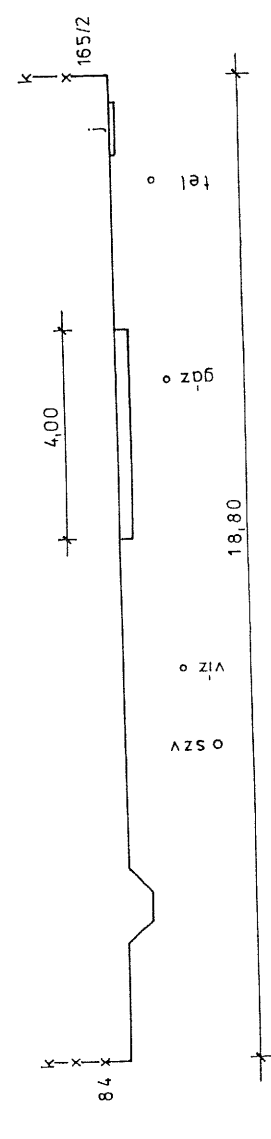

SZÉCHENYI I. U. (16)

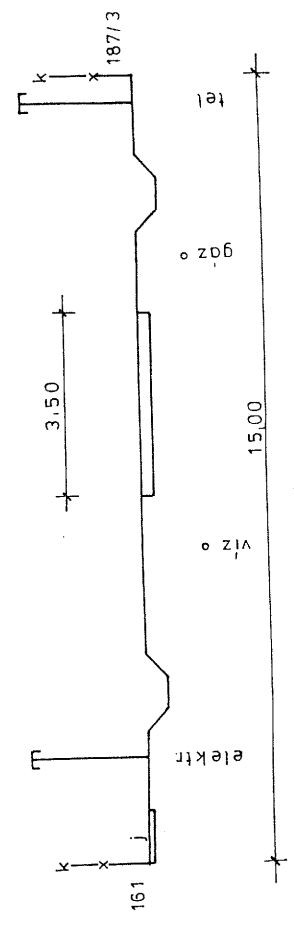

3. BARACSKA

JELLEMZŐ KERESZTSZELVÉNYEK M=1:100

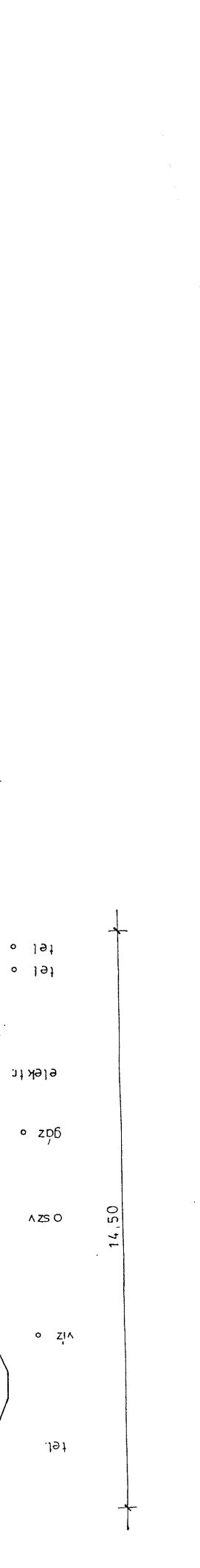
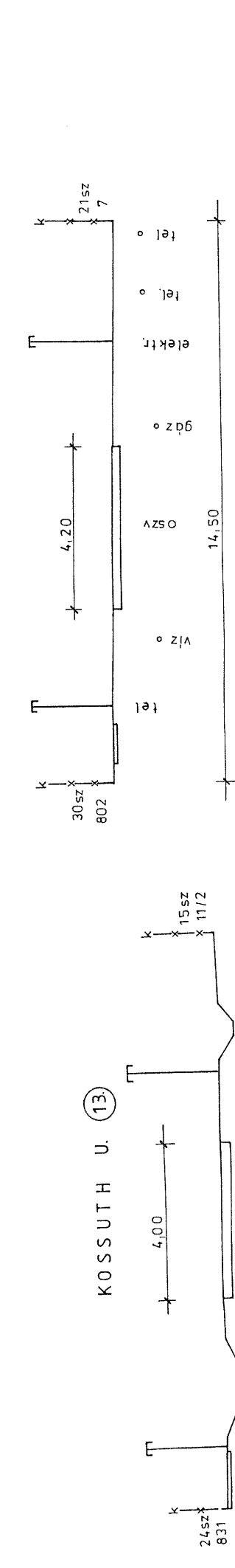
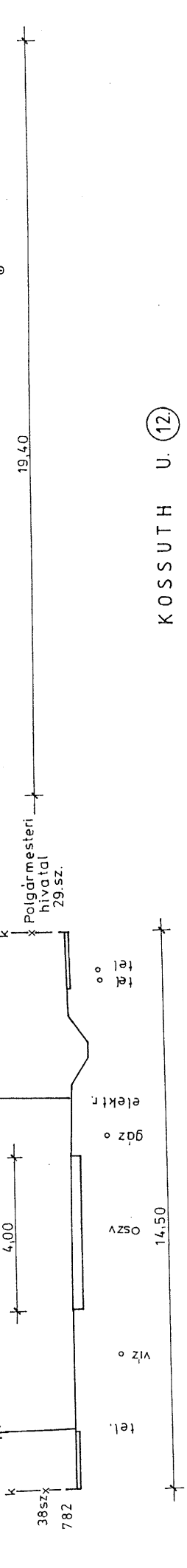
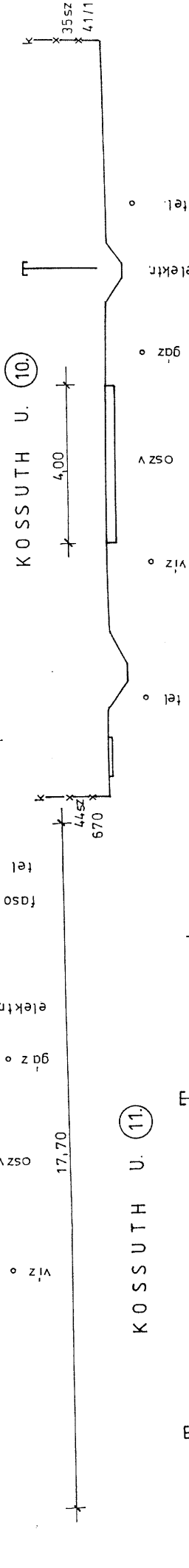
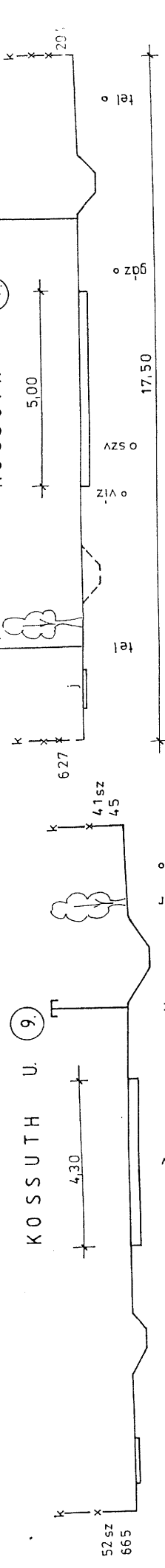

S Z É C H E N Y I I . U . (1 7 .)

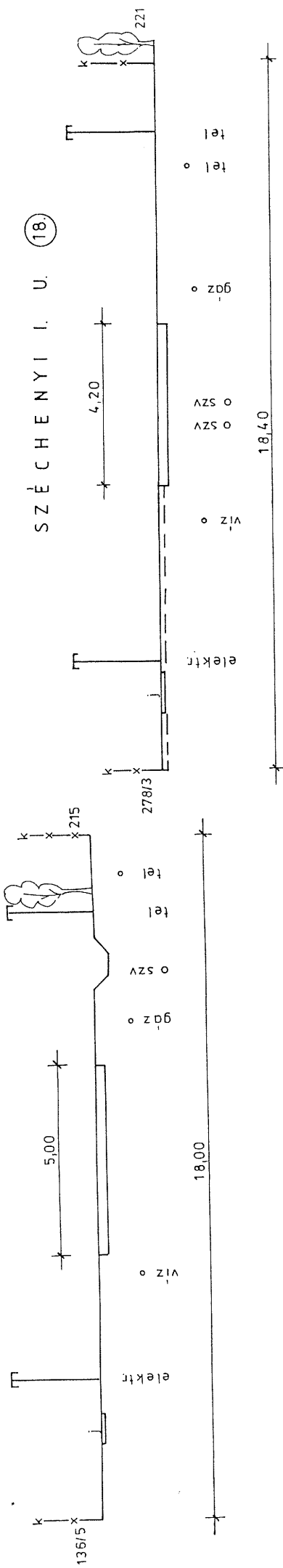

S Z É C H E N Y I I . U . (1 8 .)

T E M E S V Á R I U . (2 0 .)

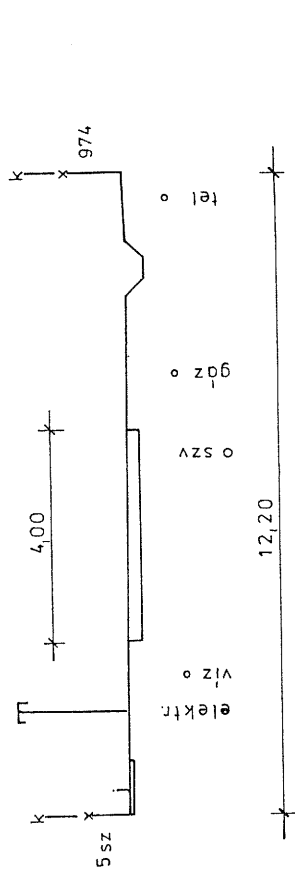

T E M E S V Á R I U . (1 9 .)

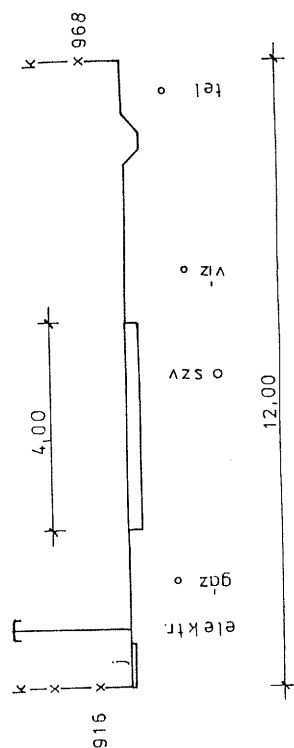

T O M P A M . U . (2 1 .)

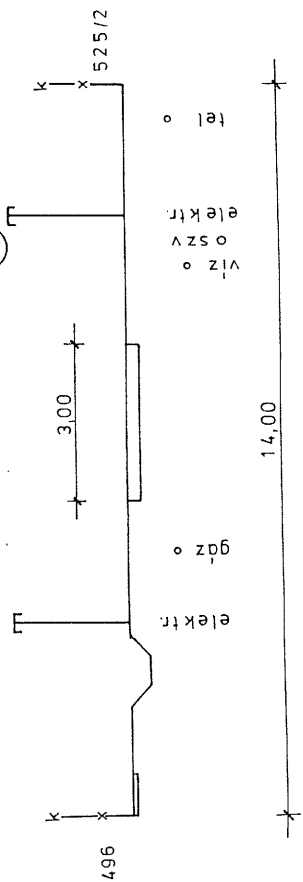

FEHÉRVÁRI U. (25)

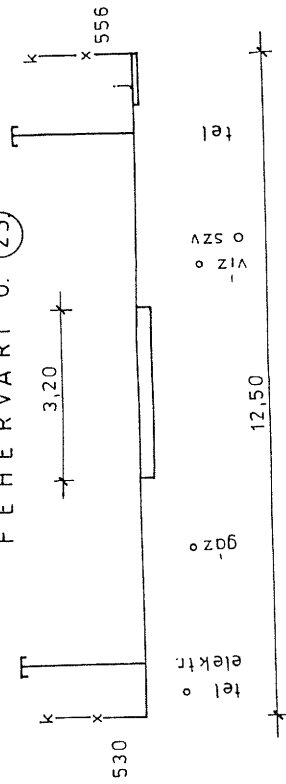

FEHÉRVÁRI U. (26)

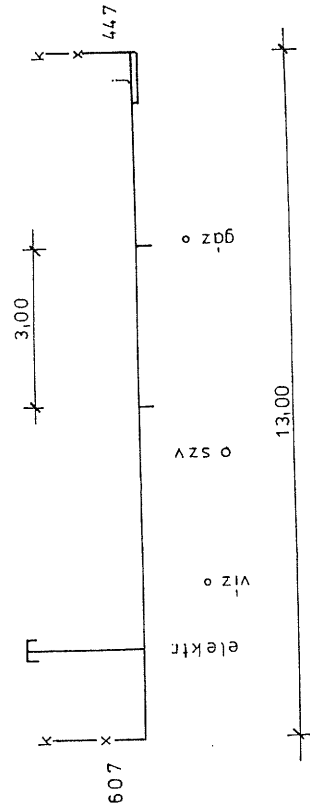

HUNYADI J. U. (27)

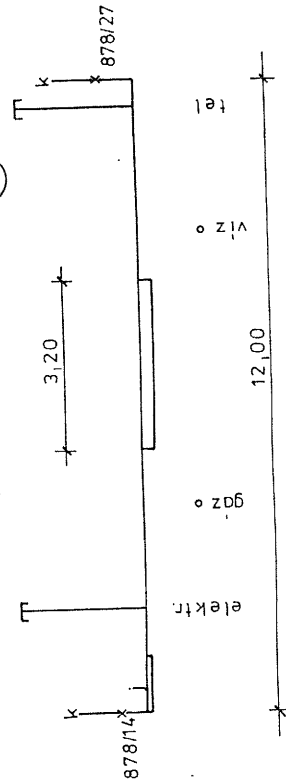

TOMPA M. U. (22)

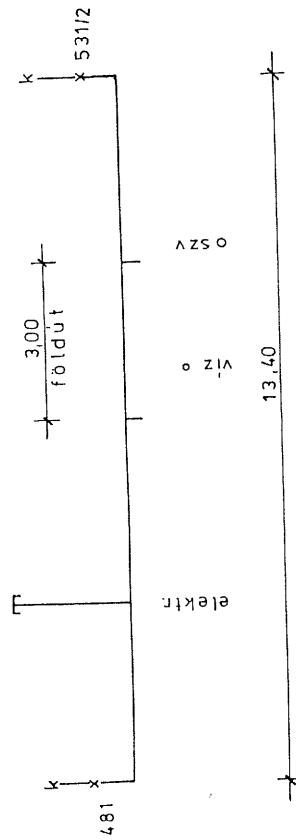

TOMPA M. U. (23)

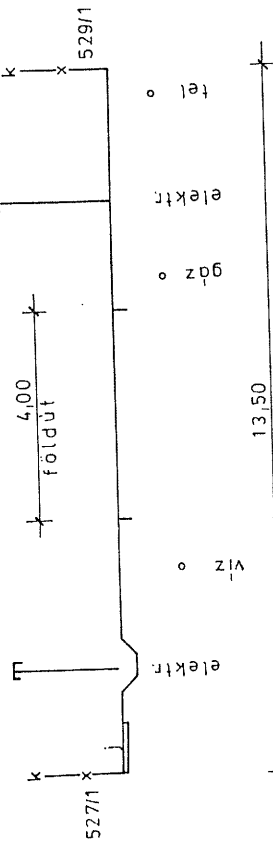

FEHÉRVÁRI U. (24)

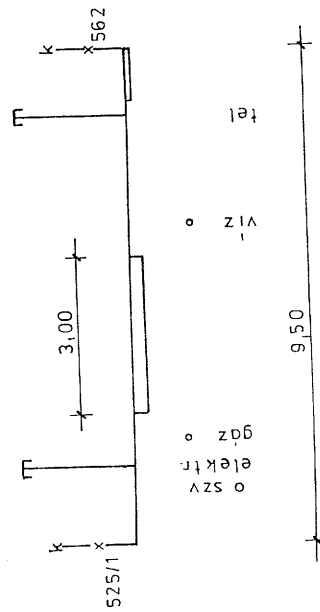

JÓZSEF A. U. (28)

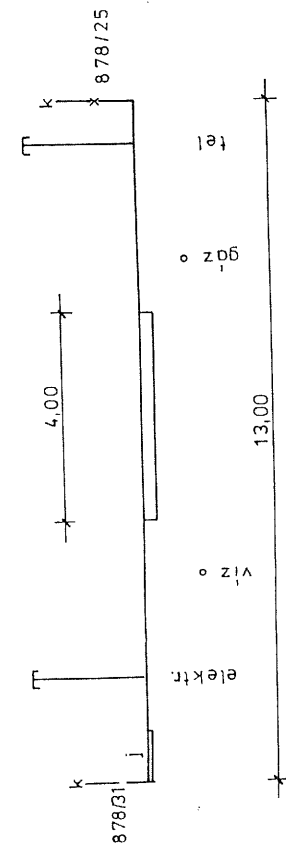

KASSAI U. (33)

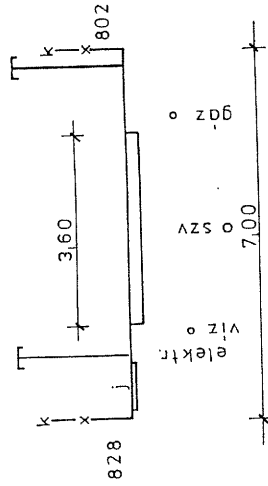

POZSONYI U. (34)

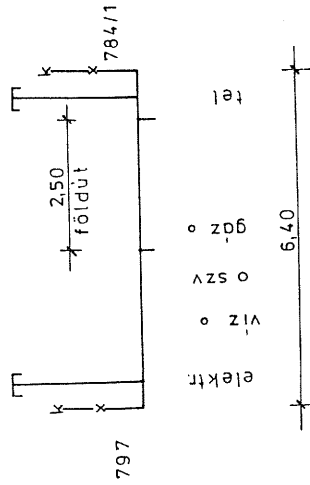

ARANY J. U. (29)

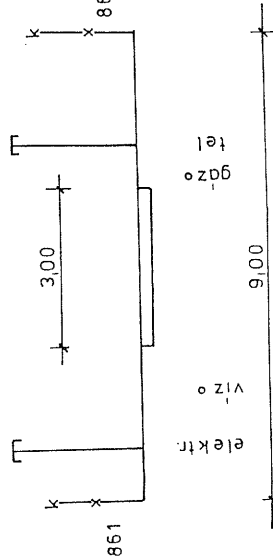

ADY E. U. (30)

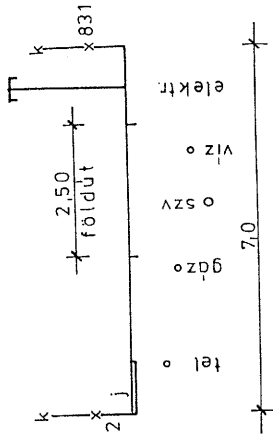

MOLNÁR U. (35)

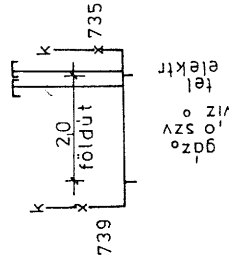

ADY E. U. (31)

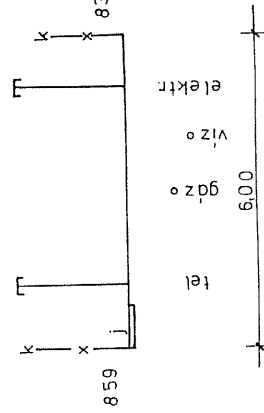

KASSAI U. (32)

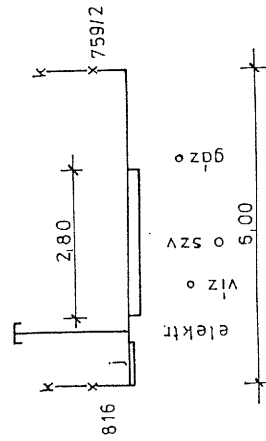

PETŐFI S. U. (36)

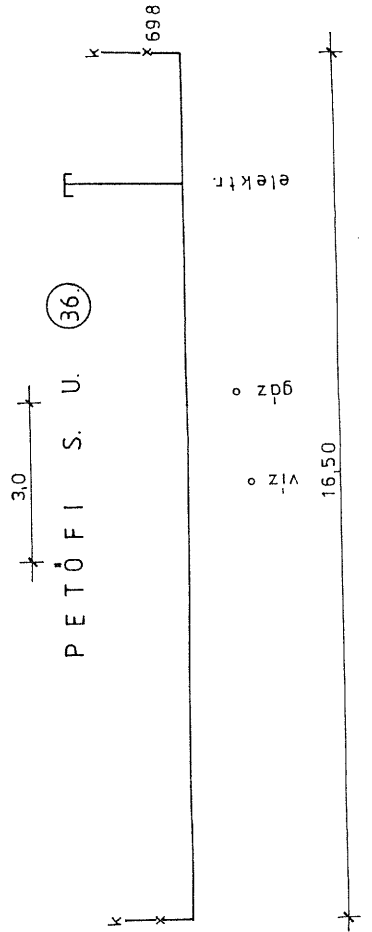

PETŐFI S. U. (37)

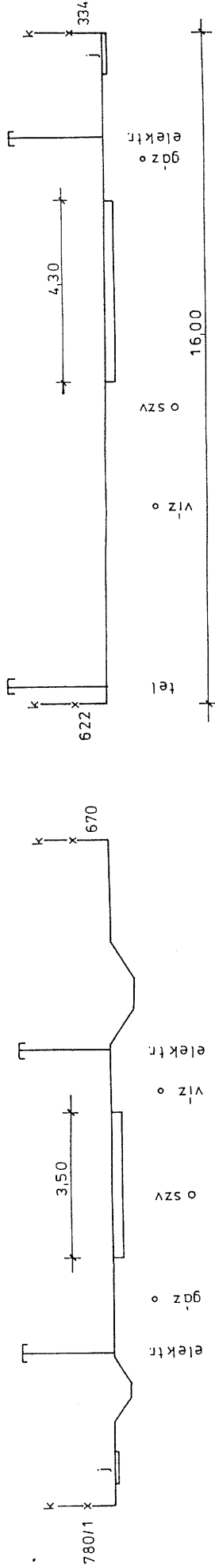

RÁKÓCZI F. KÖZ (38)

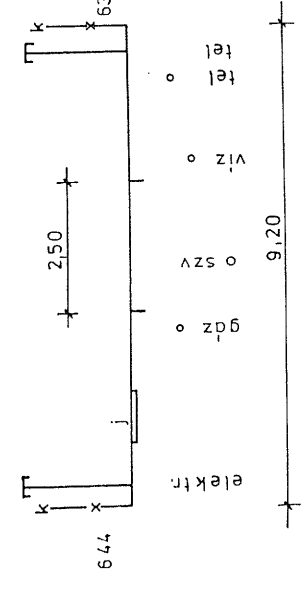

RÁKÓCZI F. KÖZ (39)

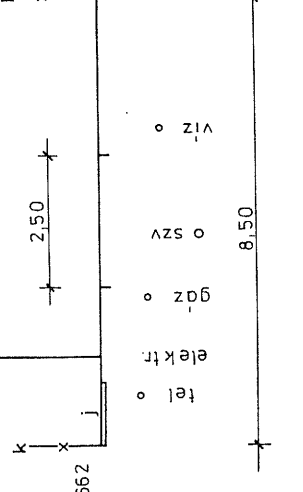

ARADI U. (42)

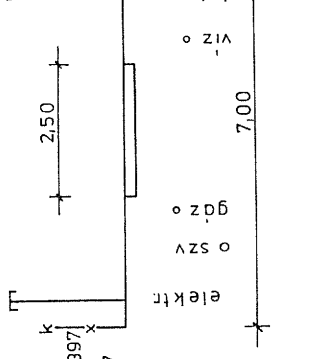

ARADI U. (43)

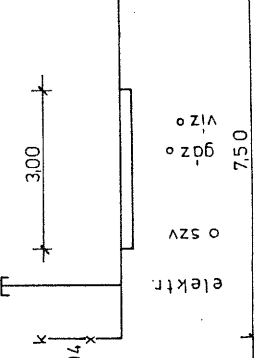

ARADI U. (40)

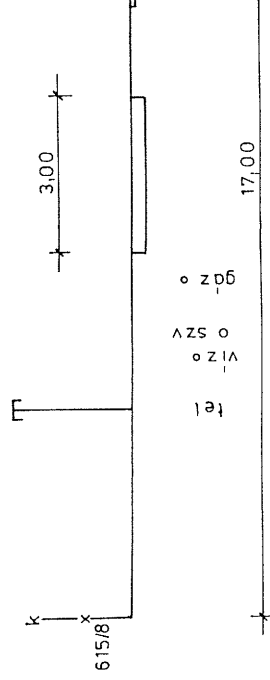

ZRINYI M. U. (44)

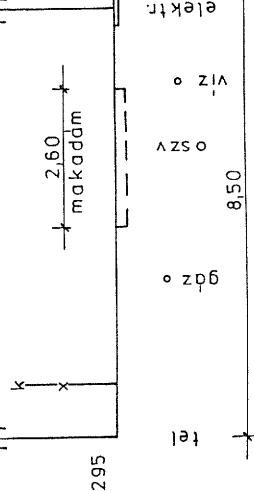

KOLOZSVÁRI U. (48)

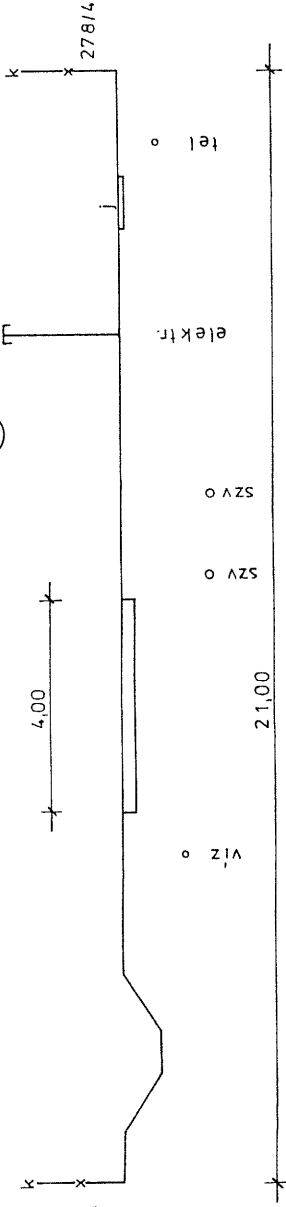

ZRINYI M. U. (45)

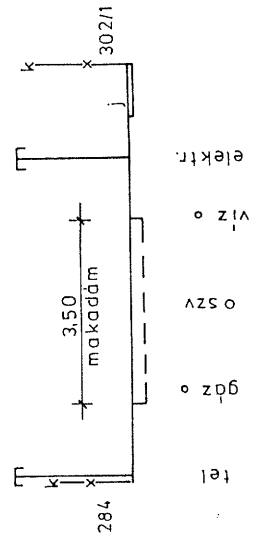

KOLOZSVÁRI U. (46)

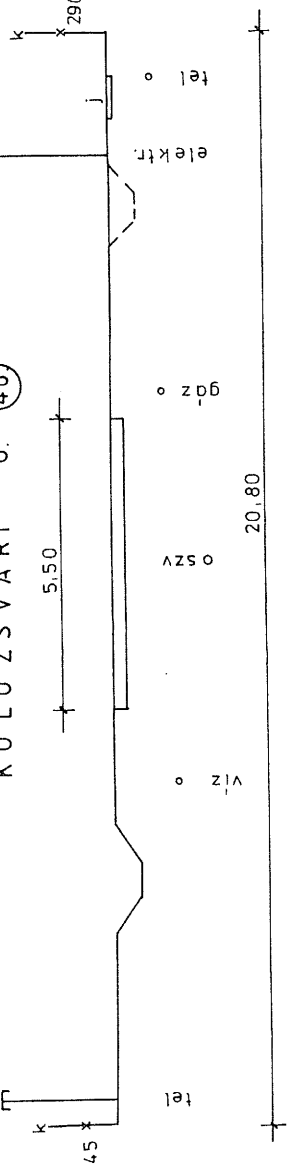

TEMLOM U. (49)

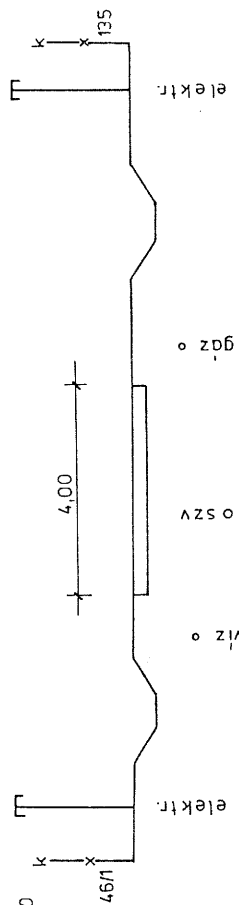

KOLOZSVÁRI U. (47)

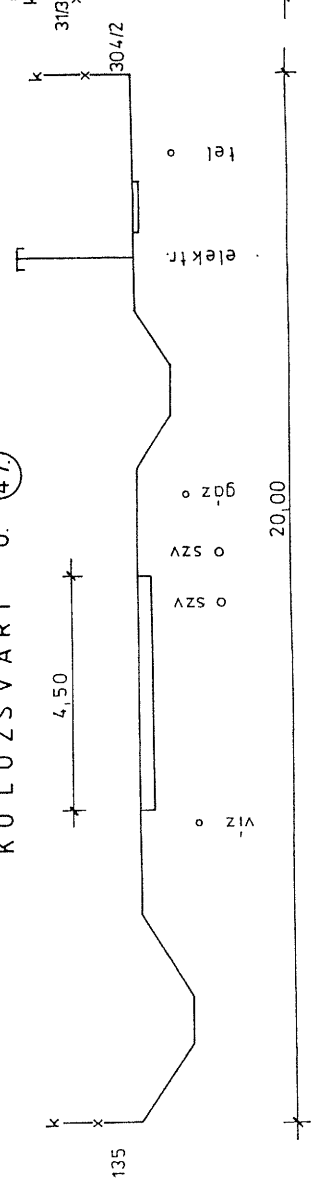

TEMLOM U. (50)

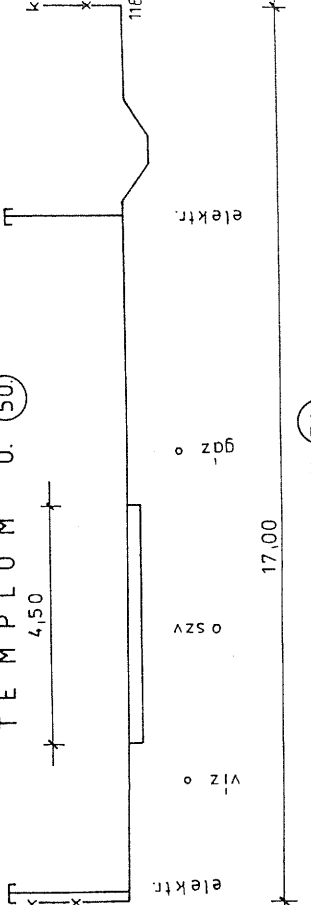

TEMLOM U. (51)

